

Recent Progress in Neutrino Physics

Carlo Giunti

INFN, Sezione di Torino, and Dipartimento di Fisica Teorica, Università di Torino

<mailto://giunti@to.infn.it>

Neutrino Unbound: <http://www.nu.to.infn.it>

La Thuile 2011

Les Rencontres de Physique de La Vallée d'Aoste

27 February - 5 March 2011

Solar and Atmospheric Neutrino Oscillations

$$\begin{array}{l}
 \text{Solar} \\
 \nu_e \rightarrow \nu_\mu, \nu_\tau \\
 \\
 \text{Reactor} \\
 \bar{\nu}_e \text{ disappearance}
 \end{array}
 \left(\begin{array}{c}
 \text{Homestake} \\
 \text{Kamiokande} \\
 \text{GALLEX/GNO \& SAGE} \\
 \text{Super-Kamiokande} \\
 \text{SNO} \\
 \text{BOREXino} \\
 \\
 \text{(KamLAND)}
 \end{array} \right)
 \rightarrow \left\{ \begin{array}{l}
 \Delta m_{\text{SOL}}^2 \simeq 7.6 \times 10^{-5} \text{ eV}^2 \\
 \sin^2 \vartheta_{\text{SOL}} \simeq 0.32
 \end{array} \right.$$

$$\begin{array}{l}
 \text{Atmospheric} \\
 \nu_\mu \rightarrow \nu_\tau \\
 \\
 \text{Accelerator} \\
 \nu_\mu \text{ disappearance}
 \end{array}
 \left(\begin{array}{c}
 \text{Kamiokande} \\
 \text{IMB} \\
 \text{Super-Kamiokande} \\
 \text{MACRO} \\
 \text{Soudan-2} \\
 \\
 \text{(K2K \& MINOS)}
 \end{array} \right)
 \rightarrow \left\{ \begin{array}{l}
 \Delta m_{\text{ATM}}^2 \simeq 2.4 \times 10^{-3} \text{ eV}^2 \\
 \sin^2 \vartheta_{\text{ATM}} \simeq 0.50
 \end{array} \right.$$

Two scales of $\Delta m^2 \iff$ Three-Neutrino Mixing

$$\Delta m_{\text{SOL}}^2 = \Delta m_{21}^2 \simeq 7.6 \times 10^{-5} \text{ eV}^2$$

$$\Delta m_{\text{ATM}}^2 \simeq |\Delta m_{31}^2| \simeq |\Delta m_{32}^2| \simeq 2.4 \times 10^{-3} \text{ eV}^2$$

LSND

[LSND, PRL 75 (1995) 2650; PRC 54 (1996) 2685; PRL 77 (1996) 3082; PRD 64 (2001) 112007]

$$\bar{\nu}_\mu \rightarrow \bar{\nu}_e$$

$$L \simeq 30 \text{ m}$$

$$20 \text{ MeV} \leq E \leq 200 \text{ MeV}$$

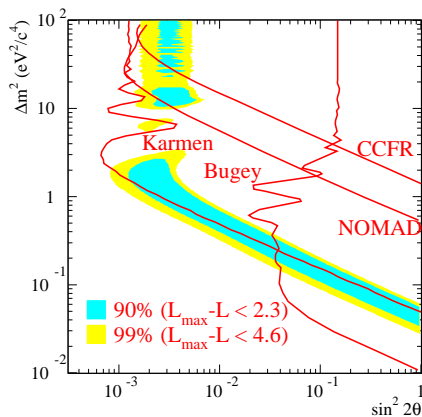
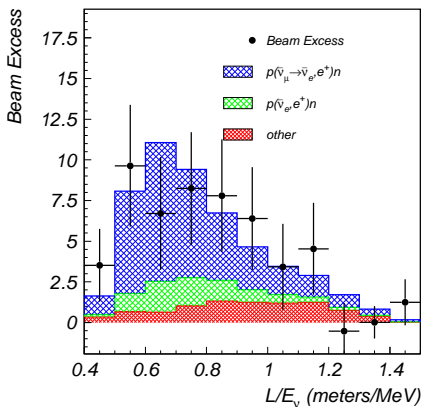

$$\Delta m_{\text{LSND}}^2 \gtrsim 0.2 \text{ eV}^2 \quad (\gg \Delta m_{\text{ATM}}^2 \gg \Delta m_{\text{SOL}}^2)$$

MiniBooNE Antineutrinos

[PRL 103 (2009) 111801; PRL 105 (2010) 181801]

$$\bar{\nu}_\mu \rightarrow \bar{\nu}_e$$

$$L \simeq 541 \text{ m}$$

$$475 \text{ MeV} \leq E \lesssim 3 \text{ GeV}$$

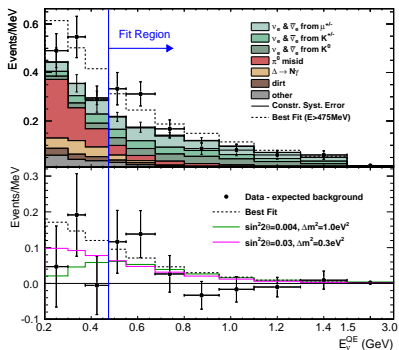

[MiniBooNE, PRL 105 (2010) 181801, arXiv:1007.1150]

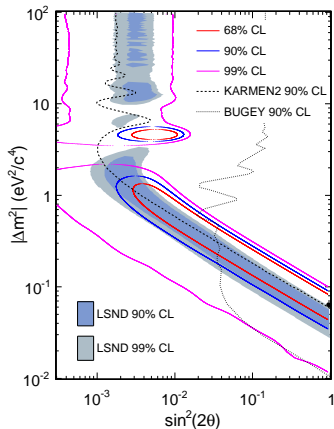

Agreement with LSND $\bar{\nu}_\mu \rightarrow \bar{\nu}_e$ signal!

Similar L/E but different L and $E \implies$ Oscillations!

Beyond Three-Neutrino Mixing

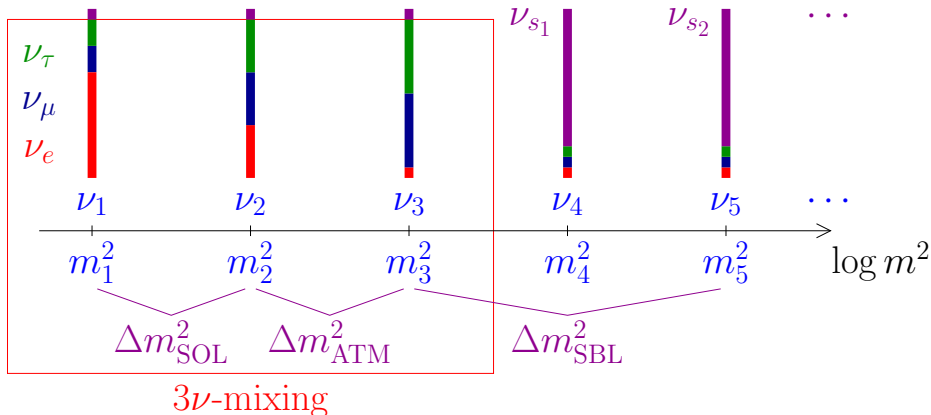

Standard Model

- ▶ Neutrinos are the only massless fermions
- ▶ Neutrinos are the only fermions with only left-handed component ν_L

Extension of the SM: Massive Neutrinos

- ▶ Simplest extension: introduce right-handed component ν_R
- ▶ Dirac mass $m_D \overline{\nu_R} \nu_L$ + Majorana mass $m_M \overline{\nu_R^c} \nu_R$
- ▶ $\nu_{eL}, \nu_{\mu L}, \nu_{\tau L} + \nu_{eR}, \nu_{\mu R}, \nu_{\tau R} \implies$ 6 massive Majorana neutrinos

Sterile Neutrinos

- ▶ Light anti- ν_R are called sterile neutrinos

$$\nu_R^c \rightarrow \nu_s \quad (\text{left-handed})$$

- ▶ Sterile means no standard model interactions
- ▶ Active neutrinos (ν_e, ν_μ, ν_τ) can oscillate into sterile neutrinos (ν_s)
- ▶ Observables:
 - ▶ Disappearance of active neutrinos
 - ▶ Indirect evidence through combined fit of data
- ▶ Powerful window on new physics beyond the Standard Model

Cosmology

- ▶ CMB and LSS in Λ CDM:

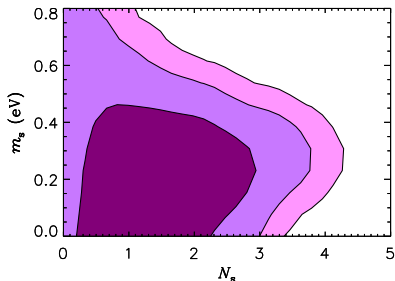

[Hamann, Hannestad, Raffelt, Tamborra, Wong, PRL 105 (2010) 181301, arXiv:1006.5276]

- ▶ BBN:
 - $N_s = 0.22 \pm 0.59$ [Cyburt, Fields, Olive, Skillman, AP 23 (2005) 313, astro-ph/0408033]
 - $N_s = 0.64^{+0.40}_{-0.35}$ [Izotov, Thuan, ApJL 710 (2010) L67, arXiv:1001.4440]

SBL Oscillation Probabilities in 3+1 Schemes

$$P_{\nu_\alpha \rightarrow \nu_\beta} = \sin^2 2\vartheta_{\alpha\beta} \sin^2 \left(\frac{\Delta m^2 L}{4E} \right)$$

$$\sin^2 2\vartheta_{\alpha\beta} = 4|U_{\alpha 4}|^2 |U_{\beta 4}|^2$$

No CP Violation!

$$P_{\nu_\alpha \rightarrow \nu_\alpha} = 1 - \sin^2 2\vartheta_{\alpha\alpha} \sin^2 \left(\frac{\Delta m^2 L}{4E} \right)$$

$$\sin^2 2\vartheta_{\alpha\alpha} = 4|U_{\alpha 4}|^2 (1 - |U_{\alpha 4}|^2)$$

Perturbation of 3ν Mixing

$$|U_{e4}|^2 \ll 1, \quad |U_{\mu 4}|^2 \ll 1, \quad |U_{\tau 4}|^2 \ll 1, \quad |U_{s4}|^2 \simeq 1$$

$$U = \begin{pmatrix} U_{e1} & U_{e2} & U_{e3} & U_{e4} \\ U_{\mu 1} & U_{\mu 2} & U_{\mu 3} & U_{\mu 4} \\ U_{\tau 1} & U_{\tau 2} & U_{\tau 3} & U_{\tau 4} \\ U_{s1} & U_{s2} & U_{s3} & U_{s4} \end{pmatrix}$$

↑
SBL

$$\sin^2 2\vartheta_{\alpha\alpha} \ll 1$$

⇓

$$|U_{\alpha 4}|^2 \simeq \frac{\sin^2 2\vartheta_{\alpha\alpha}}{4}$$

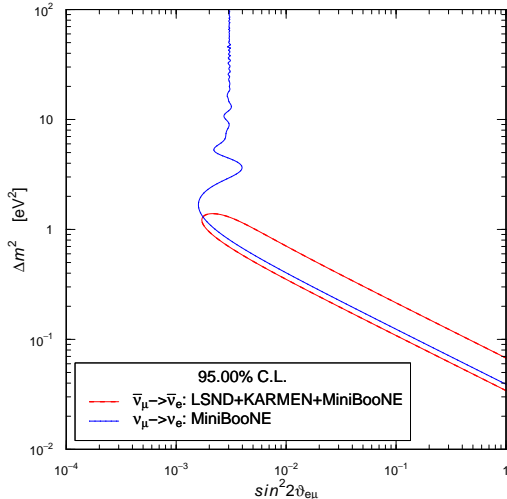

3+1 Schemes

GoF = 32%

PGoF = 0.89%

- ▶ Tension between LSND + KARMEN + MiniBooNE $\bar{\nu}_\mu \rightarrow \bar{\nu}_e$ and MiniBooNE $\nu_\mu \rightarrow \nu_e \implies$ CP Violation?
- ▶ 3+2 \implies CP Violation OK [Sorel, Conrad, Shaevitz, PRD 70 (2004) 073004, hep-ph/0305255; Maltoni, Schwetz, PRD 76, 093005 (2007), arXiv:0705.0107; Karagiorgi et al, PRD 80 (2009) 073001, arXiv:0906.1997]
- ▶ 3+1 + NSI \implies CP Violation OK [Akhmedov, Schwetz, JHEP 10 (2010) 115, arXiv:1007.4171]

$\bar{\nu}_e$ Disappearance

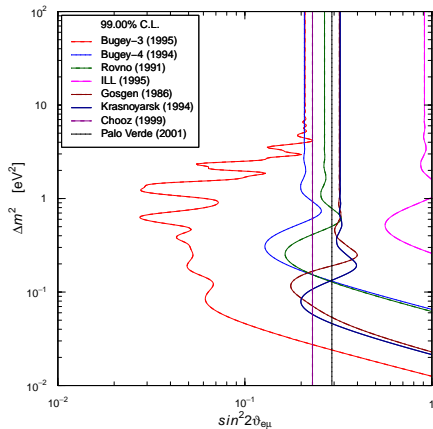

ν_μ and $\bar{\nu}_\mu$ Disappearance

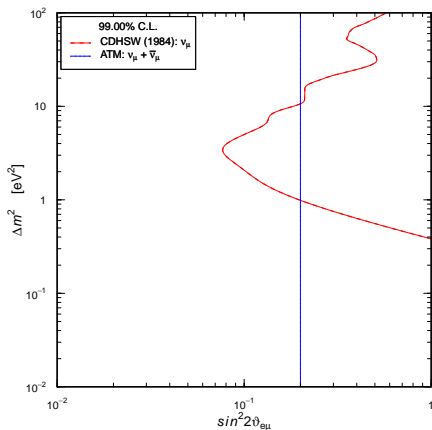

- ▶ ν_e disappearance experiments:

$$\sin^2 2\vartheta_{ee} = 4|U_{e4}|^2 (1 - |U_{e4}|^2) \simeq 4|U_{e4}|^2$$

- ▶ ν_μ disappearance experiments:

$$\sin^2 2\vartheta_{\mu\mu} = 4|U_{\mu4}|^2 (1 - |U_{\mu4}|^2) \simeq 4|U_{\mu4}|^2$$

- ▶ $\nu_\mu \rightarrow \nu_e$ experiments:

$$\sin^2 2\vartheta_{e\mu} = 4|U_{e4}|^2 |U_{\mu4}|^2 \simeq \frac{1}{4} \sin^2 2\vartheta_{ee} \sin^2 2\vartheta_{\mu\mu}$$

- ▶ Upper bounds on $\sin^2 2\vartheta_{ee}$ and $\sin^2 2\vartheta_{\mu\mu} \implies$ strong limit on $\sin^2 2\vartheta_{e\mu}$

[Okada, Yasuda, Int. J. Mod. Phys. A12 (1997) 3669-3694, arXiv:hep-ph/9606411]

[Bilenky, Giunti, Grimus, Eur. Phys. J. C1 (1998) 247, arXiv:hep-ph/9607372]

3+1 Schemes

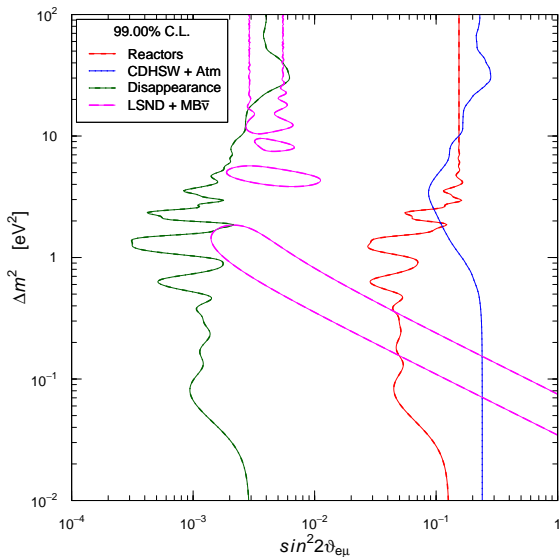

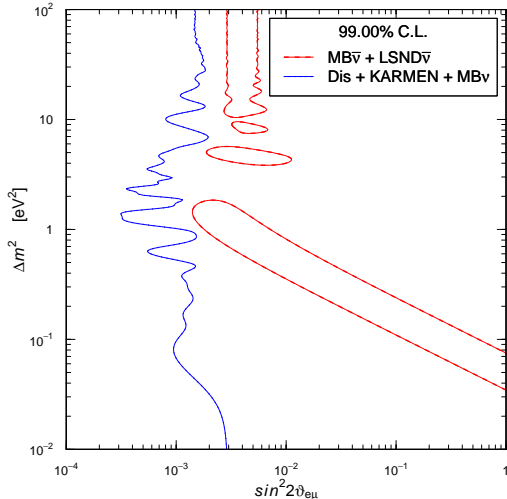

3+1 Schemes

GoF = 39%

PGoF = 0.0052%

- ▶ Strong tension between $\bar{\nu}_\mu \rightarrow \bar{\nu}_e$ appearance and disappearance limits ($\bar{\nu}_e \rightarrow \bar{\nu}_e$ and mainly $\nu_\mu \rightarrow \nu_\mu$)
- ▶ Tension persists in 3+2, 3+3, ... schemes. Reduced by NSI
- ▶ CPT Violation?

[Barger, Marfatia, Whisnant, PLB 576 (2003) 303]

[Giunti, Laveder, PRD 82 (2010) 093016, arXiv:1010.1395; arXiv:1012.0267]

Antineutrino Oscillations in 3+1 Schemes

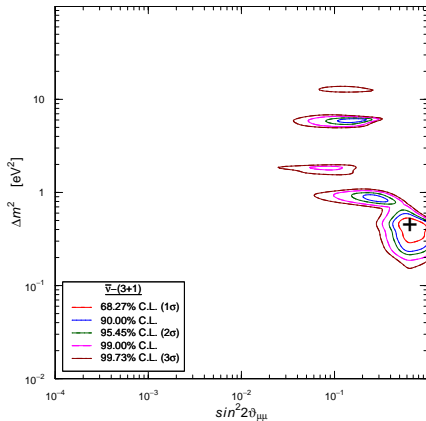
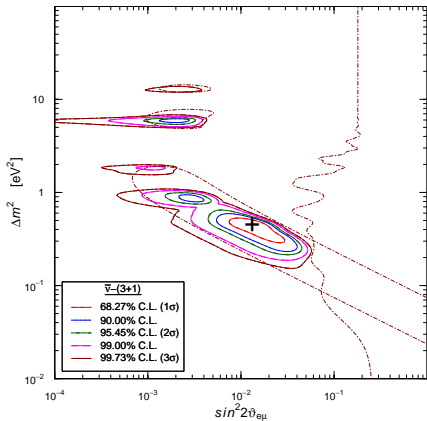

$$\chi_{\min}^2 = 82.0 \quad \text{NdF} = 83 \quad \text{GoF} = 51\%$$

$$\Delta m^2 = 0.45 \text{ eV}^2 \quad \sin^2 2\vartheta_{e\mu} = 0.013 \quad \sin^2 2\vartheta_{ee} = 0.017 \quad \sin^2 2\vartheta_{\mu\mu} = 0.65$$

Prediction: large SBL $\bar{\nu}_\mu$ disappearance at $0.1 \lesssim \Delta m^2 \lesssim 1 \text{ eV}^2$

[Giunti, Laveder, arXiv:1012.0267]

New Calculation of Reactor $\bar{\nu}_e$ Flux

- ▶ Th. A. Mueller, D. Lhuillier, M. Fallot, A. Letourneau, S. Cormon, M. Fechner, L. Giot, T. Lasserre, J. Martino, G. Mention, A. Porta, F. Yermia, Improved Predictions of Reactor Antineutrino Spectra, arXiv:1101.2663
- ▶ detected flux normalization is increased by about 3%

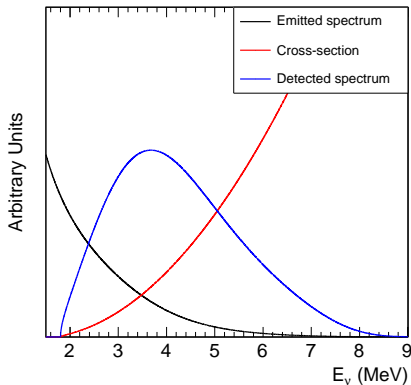

- ▶ G. Mention, M. Fechner, Th. Lasserre, Th. A. Mueller, D. Lhuillier, M. Cribier, A. Letourneau, **The Reactor Antineutrino Anomaly**, arXiv:1101.2755
- ▶ ratio of observed and predicted event rates: 0.937 ± 0.027
- ▶ deviation from unity at 98.4% C.L.: reactor antineutrino anomaly

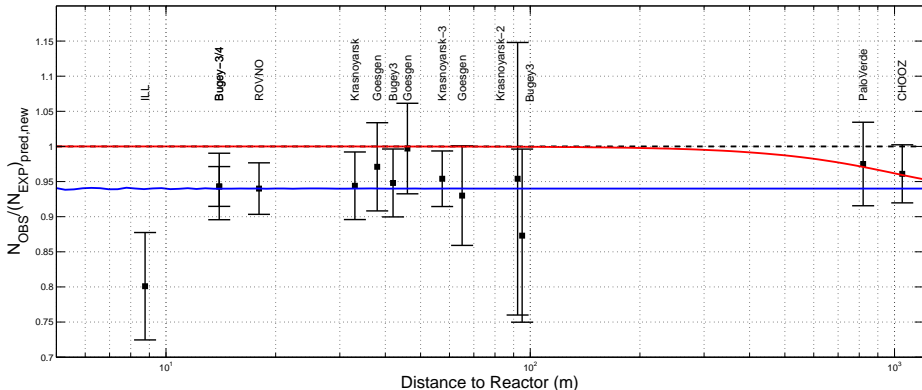

- ▶ New reactor neutrino flux has several implications: fit of solar and KamLAND data, determination of ϑ_{13} , short-baseline $\bar{\nu}_e$ disappearance, ...

Chooz limit on ϑ_{13}

[Chooz, EPJC 27 (2003) 331]

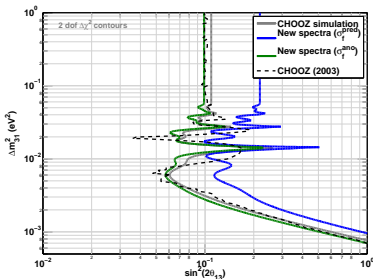

[Mention et al., arXiv:1101.2755]

Hint of $\vartheta_{13} > 0$

[Fogli et al., PRL 101 (2008) 141801]

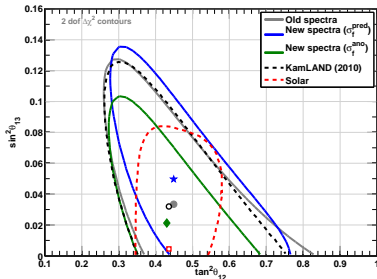

[Mention et al., arXiv:1101.2755]

SBL Oscillations in 3+1 Spectra

Standard Reactor $\bar{\nu}_e$ Fluxes

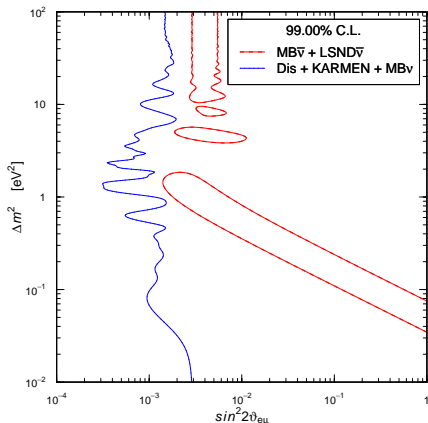

PGoF = 0.0052%

New Reactor $\bar{\nu}_e$ Fluxes

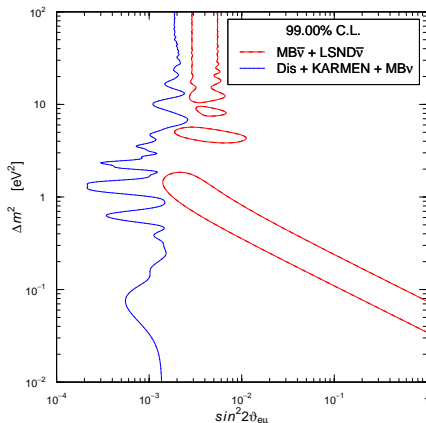

PGoF = 0.010%

- ▶ Tension between $\bar{\nu}_\mu \rightarrow \bar{\nu}_e$ appearance and disappearance limits is decreased, but still strong

Gallium Anomaly

Gallium Radioactive Source Experiments

Tests of the solar neutrino detectors **GALLEX** (Cr1, Cr2) and **SAGE** (Cr, Ar)

Detection Process: $\nu_e + {}^{71}\text{Ga} \rightarrow {}^{71}\text{Ge} + e^-$

ν_e Sources: $e^- + {}^{51}\text{Cr} \rightarrow {}^{51}\text{V} + \nu_e$ $e^- + {}^{37}\text{Ar} \rightarrow {}^{37}\text{Cl} + \nu_e$

	${}^{51}\text{Cr}$				${}^{37}\text{Ar}$	
E [keV]	747	752	427	432	811	813
B.R.	0.8163	0.0849	0.0895	0.0093	0.902	0.098

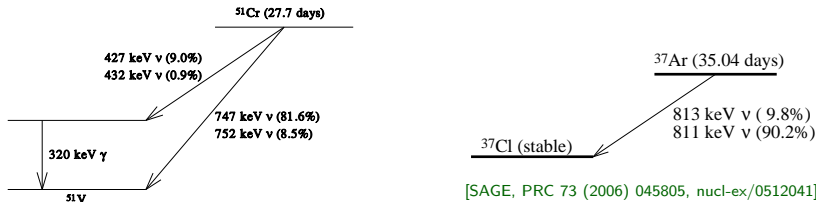

[SAGE, PRC 59 (1999) 2246, hep-ph/9803418]

[SAGE, PRC 73 (2006) 045805, nucl-ex/0512041]

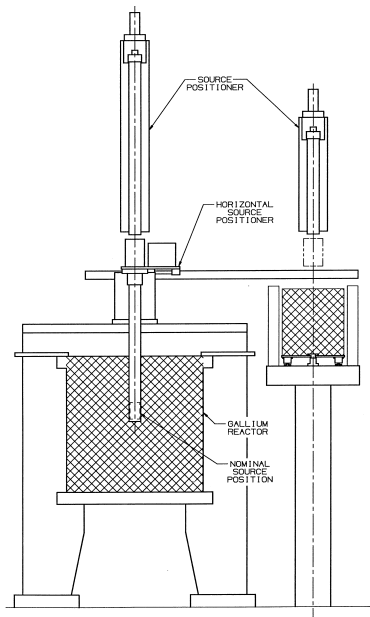

[SAGE, PRC 59 (1999) 2246, hep-ph/9803418]

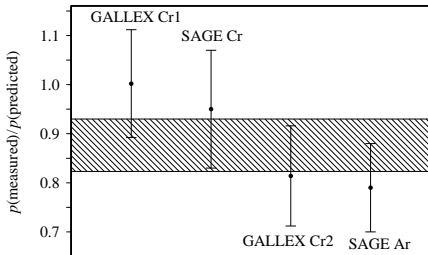

[SAGE, PRC 73 (2006) 045805, nucl-ex/0512041]

$$R_{\text{Ga}} = 0.86 \pm 0.05$$

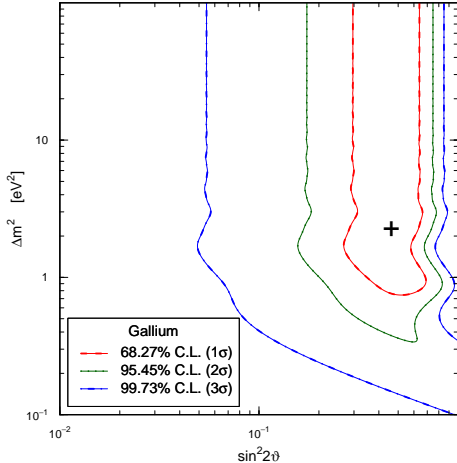

[Giunti, Laveder, arXiv:1006.3244]

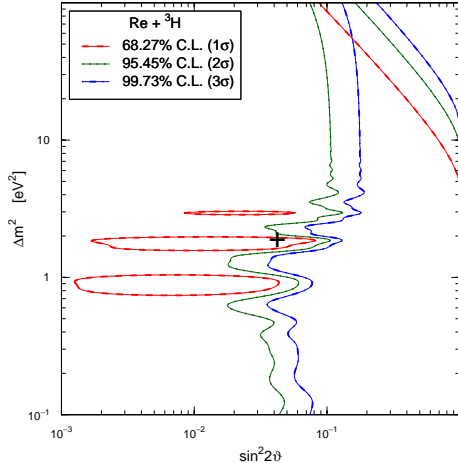

[Giunti, Laveder, PRD 82 (2010) 053005, arXiv:1005.4599]

$\Delta m_{\text{SBL}}^2 \gtrsim 1 \text{ eV}^2$ is OK, but $\sin^2 2\vartheta_\nu > \sin^2 2\vartheta_{\bar{\nu}}$

Parameter Goodness of Fit = 0.2%

CPT violation?

[Giunti, Laveder, PRD 82 (2010) 113009, arXiv:1008.4750]

Gallium Anomaly

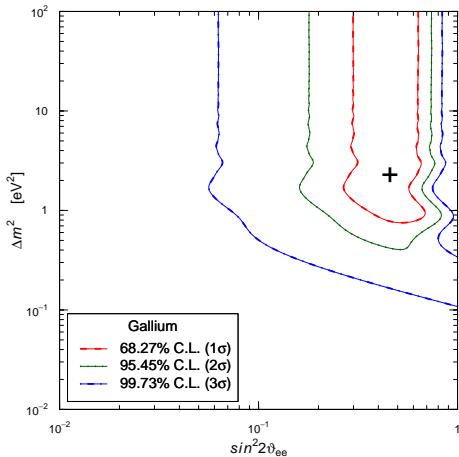

Reactor Anomaly

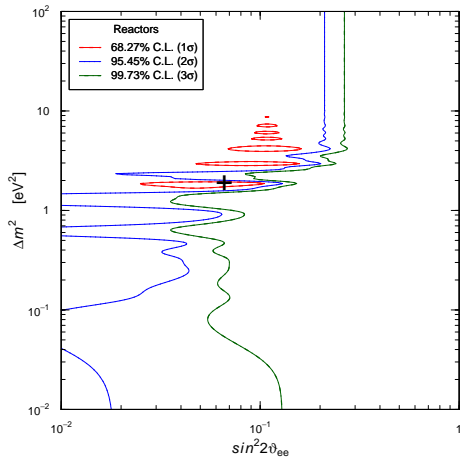

Gallium Anomaly + Reactor Anomaly

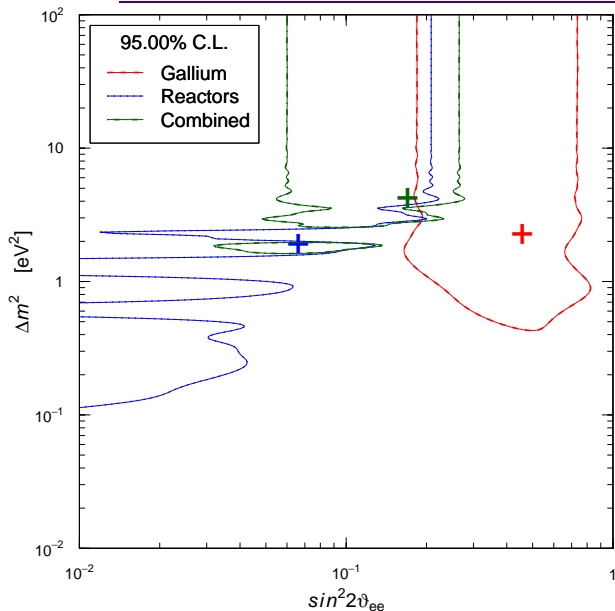

$$\chi_{\min}^2 = 59.8$$

$$\text{NdF} = 65$$

$$\text{GoF} = 66\%$$

$$\sin^2 2\vartheta = 0.17$$

$$\Delta m^2 = 4.17 \text{ eV}^2$$

$$\text{PGoF} = 1.1\%$$

Conclusions

- ▶ Suggestive LSND and MiniBooNE agreement on SBL $\bar{\nu}_\mu \rightarrow \bar{\nu}_e$ oscillations
- ▶ Hint in favor of sterile neutrinos is compatible with cosmological data, but mass is limited
- ▶ Three experimental tensions:
 - ▶ LSND and MiniBooNE $\bar{\nu}_\mu \rightarrow \bar{\nu}_e$ vs MiniBooNE $\nu_\mu \rightarrow \nu_e$ (CP violation?)
 - ▶ LSND and MiniBooNE $\bar{\nu}_\mu \rightarrow \bar{\nu}_e$ vs $\bar{\nu}_e$ and ν_μ disappearance limits
 - ▶ Gallium Anomaly (ν_e disappearance) vs Reactor ($\bar{\nu}_e$ disappearance), maybe resolved by **Reactor Anomaly**
- ▶ CPT-invariant 3+1 Four-Neutrino Mixing is strongly disfavored (no CP violation and tension between appearance and disappearance)
- ▶ 3+2 Five-Neutrino Mixing can explain CP violation but tension between appearance and disappearance persists (reduced by NSI)
- ▶ CPT-violating 3+1 Mixing \implies large SBL $\bar{\nu}_\mu$ disappearance
- ▶ Work in Progress: combined explanation of LSND and MiniBooNE + Gallium and Reactor Anomaly
- ▶ **New short-baseline neutrino oscillation experiments are needed!**

Backup Slides

How many Sterile Neutrinos?

$$e^+e^- \rightarrow Z \xrightarrow{\text{invisible}} \sum_{a=\text{active}} \nu_a \bar{\nu}_a$$

[LEP, Phys. Rept. 427 (2006) 257, hep-ex/0509008]

3 light active flavor neutrinos

$$\nu_e \quad \nu_\mu \quad \nu_\tau$$

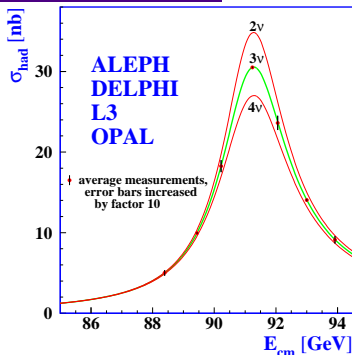

mixing $\Rightarrow \nu_{\alpha L} = \sum_{k=1}^N U_{\alpha k} \nu_{kL} \quad \alpha = e, \mu, \tau$

$N \geq 3$
no upper limit!

Mass Basis: $\nu_1 \quad \nu_2 \quad \nu_3 \quad \nu_4 \quad \nu_5 \quad \dots$

Flavor Basis: $\nu_e \quad \nu_\mu \quad \nu_\tau \quad \nu_{s1} \quad \nu_{s2} \quad \dots$

ACTIVE

STERILE

Four-Neutrino Schemes: 2+2 and 3+1

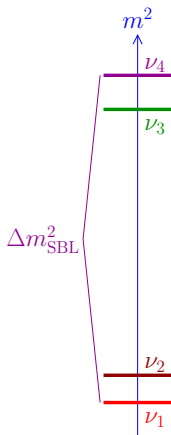

"2+2"

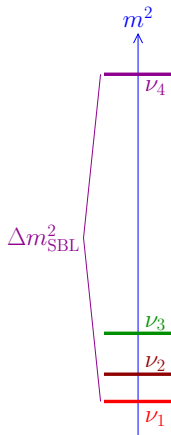

"3+1"

2+2 Four-Neutrino Schemes

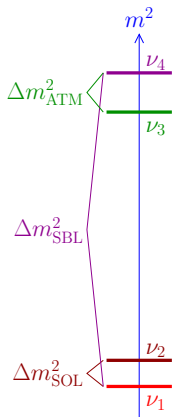

"normal"

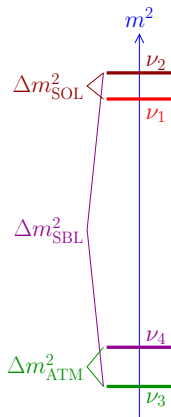

"inverted"

2+2 Schemes are strongly disfavored by solar and atmospheric data

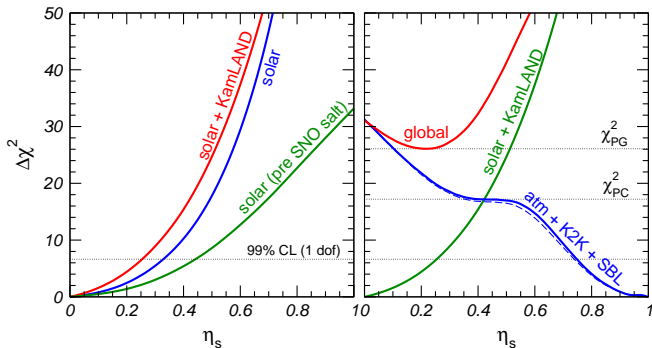

[Maltoni, Schwetz, Tortola, Valle, New J. Phys. 6 (2004) 122, arXiv:hep-ph/0405172]

$$\eta_s = |U_{s1}|^2 + |U_{s2}|^2 \quad 99\% \text{ CL: } \begin{cases} \eta_s < 0.25 & \text{(solar + KamLAND)} \\ \eta_s > 0.75 & \text{(atmospheric + K2K)} \end{cases}$$

3+1 Four-Neutrino Schemes

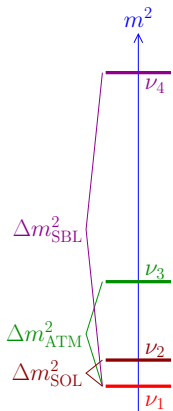

"normal"

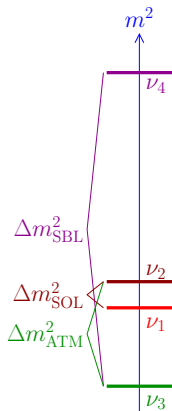

"3 ν -inverted"

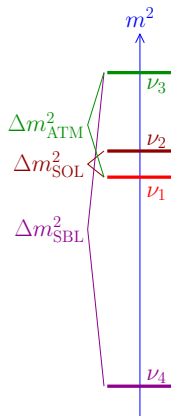

"4 ν -inverted"

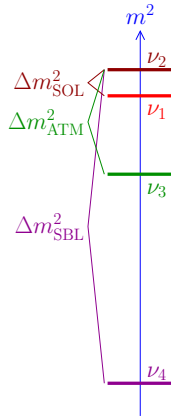

"fully-inverted"

Perturbation of 3- ν Mixing

$$|U_{e4}|^2 \ll 1$$

$$|U_{\mu 4}|^2 \ll 1$$

$$|U_{\tau 4}|^2 \ll 1$$

$$|U_{S4}|^2 \simeq 1$$

3+1 Schemes

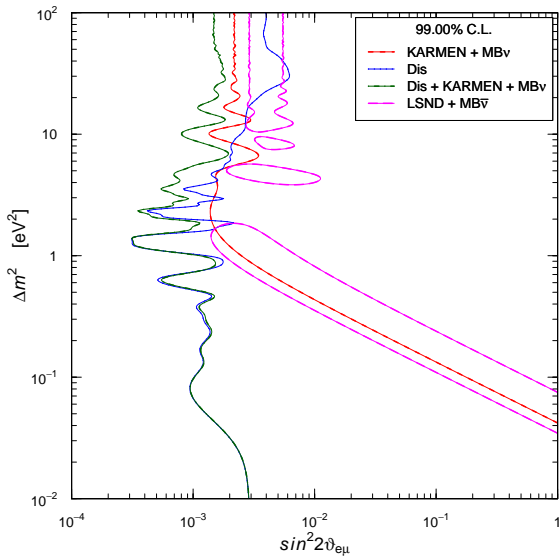

MINOS Hint of CPT Violation

LBL ν_μ disappearance

$E \sim 3 \text{ GeV}$

Near Detector at 1.04 km

Far Detector at 734 km

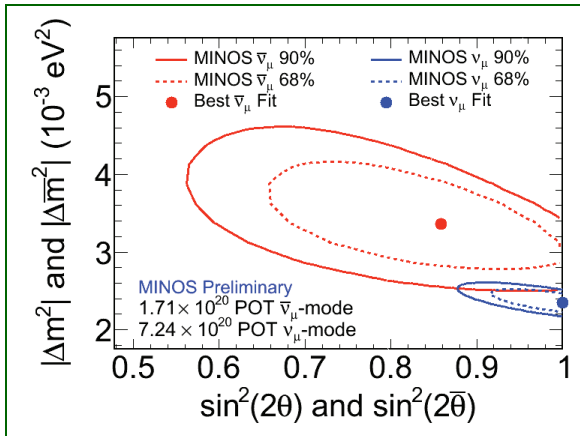

[MINOS, Neutrino 2010, 14 June 2010]

- ▶ Deficit could be due to overestimate of

$$\sigma(\nu_e + {}^{71}\text{Ga} \rightarrow {}^{71}\text{Ge} + e^-)$$

- ▶ Calculation: Bahcall, PRC 56 (1997) 3391, hep-ph/9710491

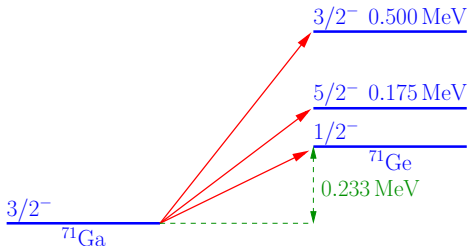

- ▶ $\sigma_{\text{G.S.}}$ related to measured $\sigma(e^- + {}^{71}\text{Ge} \rightarrow {}^{71}\text{Ga} + \nu_e)$:

$$\sigma_{\text{G.S.}}({}^{51}\text{Cr}) = 55.3 \times 10^{-46} \text{ cm}^2 (1 \pm 0.004)_{3\sigma}$$

- ▶ $\sigma({}^{51}\text{Cr}) = \sigma_{\text{G.S.}}({}^{51}\text{Cr}) \left(1 + 0.669 \frac{\text{BGT}_{175 \text{ keV}}}{\text{BGT}_{\text{G.S.}}} + 0.220 \frac{\text{BGT}_{500 \text{ keV}}}{\text{BGT}_{\text{G.S.}}} \right)$

- ▶ Contribution of Excited States only 5%!

► Bahcall:

[Bahcall, PRC 56 (1997) 3391, hep-ph/9710491]

from $p + {}^{71}\text{Ga} \rightarrow {}^{71}\text{Ge} + n$ measurements [Krofcheck et al., PRL 55 (1985) 1051]

$$\frac{\text{BGT}_{175 \text{ keV}}}{\text{BGT}_{\text{G.S.}}} < 0.056 \Rightarrow \frac{\text{BGT}_{175 \text{ keV}}}{\text{BGT}_{\text{G.S.}}} = \frac{0.056}{2} \quad \frac{\text{BGT}_{500 \text{ keV}}}{\text{BGT}_{\text{G.S.}}} = 0.146$$

$$3\sigma \text{ lower limit: } \frac{\text{BGT}_{175 \text{ keV}}}{\text{BGT}_{\text{G.S.}}} = \frac{\text{BGT}_{500 \text{ keV}}}{\text{BGT}_{\text{G.S.}}} = 0$$

$$3\sigma \text{ upper limit: } \frac{\text{BGT}_{175 \text{ keV}}}{\text{BGT}_{\text{G.S.}}} < 0.056 \times 2 \quad \frac{\text{BGT}_{500 \text{ keV}}}{\text{BGT}_{\text{G.S.}}} = 0.146 \times 2$$

$$\sigma({}^{51}\text{Cr}) = 58.1 \times 10^{-46} \text{ cm}^2 \left(1_{-0.028}^{+0.036} \right)_{1\sigma} \Rightarrow \boxed{R_{\text{Ga}} = 0.86 \pm 0.05}$$

► Haxton:

[Hata, Haxton, PLB 353 (1995) 422, nucl-th/9503017; Haxton, PLB 431 (1998) 110, nucl-th/9804011]

“a sophisticated shell model calculation is performed ... for the transition to the first excited state in ${}^{71}\text{Ge}$. The calculation predicts destructive interference between the (p, n) spin and spin-tensor matrix elements.”

$$\sigma({}^{51}\text{Cr}) = 63.9 \times 10^{-46} \text{ cm}^2 (1 \pm 0.106)_{1\sigma} \Rightarrow \boxed{R_{\text{Ga}} = 0.76_{-0.08}^{+0.09}}$$

Future

- ▶ New Gallium source experiments: ν_e disappearance [Gavrin et al, arXiv:1006.2103]
- ▶ CPT test: ν_e and $\bar{\nu}_e$ disappearance
- ▶ Beta-Beam experiments: [Antusch, Fernandez-Martinez, PLB 665 (2008) 190, arXiv:0804.2820]

$$N(A, Z) \rightarrow N(A, Z + 1) + e^- + \bar{\nu}_e \quad (\beta^-)$$

$$N(A, Z) \rightarrow N(A, Z - 1) + e^+ + \nu_e \quad (\beta^+)$$

- ▶ Neutrino Factory experiments: [Giunti, Laveder, Winter, PRD 80 (2009) 073005, arXiv:0907.5487]

$$\mu^+ \rightarrow \bar{\nu}_\mu + e^+ + \nu_e$$

$$\mu^- \rightarrow \nu_\mu + e^- + \bar{\nu}_e$$

- ▶ New ν_e and $\bar{\nu}_e$ radioactive source experiments with low-threshold neutrino elastic scattering detectors.
- ▶ LENS (Low Energy Neutrino Spectroscopy): [Agarwalla, Raghavan, arXiv:1011.4509]



► Borexino:

[Ianni, Montanino, Scioscia, EPJC 8 (1999) 609, arXiv:hep-ex/9901012]

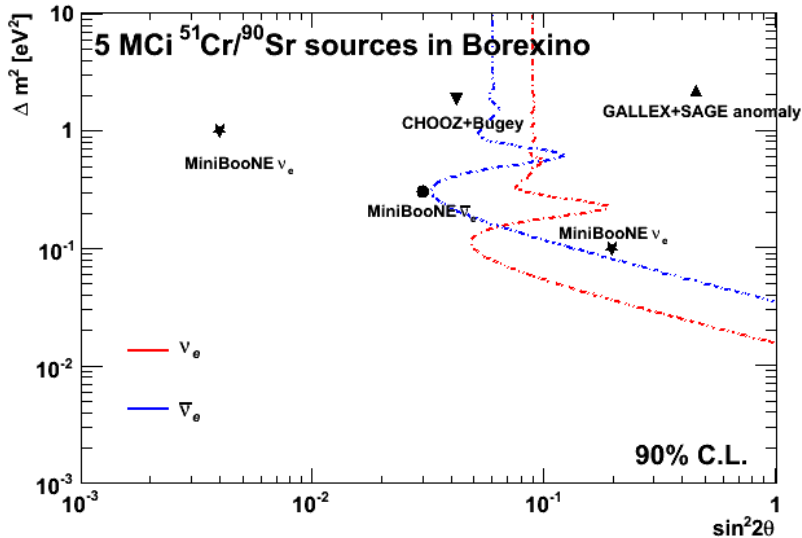

[A. Ianni, Private Communication]